

RISCO GROUP

**Gardtec**

**370 581/582**

**User Instructions**

# Contents

Introduction	1
Keypads	1
User Levels and Options	1
Master Code Flow Chart	3
Setting and Unsetting the System	4
Removing Zones and Setting the System	5
Testing the System	6
Viewing the Log	7
Setting the Chime On/Off	8
Changing Codes	9
Resetting after an Alarm	10
Display Messages	
System	11
Status	11
Log	12
Glossary of Terms	13

## Introduction

---

Welcome to the Gardtec 360/580 Control panel. Your Control panel will have already been programmed to suit the system that you have had installed by your engineer and you will have been left with at least one Master user code by the engineer. This code will allow you to program other user codes and perform other programmable functions with the Control panel. We will deal with these other functions a little later. For people not familiar with the terminology used in this manual a glossary of terms can be found on page 13.

## Keypads

---

Control of the system is via numeric keypad (fitted onboard on Gardtec 580). Up to four remote key pads may have been fitted to the system. These keypads may be used to carry out all operations that are available with the Control panel.

If the keypad alert keys have been programmed by your engineer they can be activated by pressing and holding keys 1 and 3 at the same time.

## User levels and options

---

As stated in the introduction, one code will have been given to you by the engineer. This code will allow you access to all user options and is known as the Master code. The Master code can never be deleted from the system but it may be changed by the Master user. The Master code may also be used to program other user codes.

Options available by using the Master code are as follows:-

### SET

This option allows the system to be Fully Set.

### UNSET

This option allows the system to be Unset.

### PART SET

This option allows the system to be:-

- |            |  |
|------------|--|
| Part Set 1 | Set with a suite of zones (pre-programmed by engineer) removed.        |
| Part Set 2 | Set with a second suite of zones (pre-programmed by engineer) removed. |
| Part Set 3 | Set with both Part 1 and Part 2 zone suites removed.                   |

**RESET**

If programmed by the engineer allows the system to be reset after an alarm.

**REMOVE**

Set the system with one or more zones (selected by the Master user) removed.

**TEST**

Allows the system to be tested (zones and bells/strobe)

**LOG**

Allows the Log to be read. The Log holds a record of operations/activations of the system

**CHIME**

Allows the Chime function for one or more zones (pre-programmed by engineer) to be turned On or Off.

**USER CODES**

Allows the Master code and User codes to be programmed.

**All User codes are programmed by use of the Master code. Once programmed User level codes may only access the following options:-**

**SET**

This option allows the system to be Fully Set.

**UNSET**

This option allows the system to be Unset.

**PART SET**

This option allows the system to be:-

- |            |  |
|------------|--|
| Part Set 1 | Set with a suite of zones (pre-programmed by engineer) removed.        |
| Part Set 2 | Set with a second suite of zones (pre-programmed by engineer) removed. |
| Part Set 3 | Set with both Part 1 and Part 2 zone suites removed.                   |

**RESET**

If programmed by the engineer allows the system to be reset after an alarm.

**Each of the above functions will be dealt with in its own section.**

The flow chart shown below gives the order of the screens when the Master code is used to access the system.

**KEY TO SCREENS:-**

- Un = Unset
- SE = Set
- r E = Remove Zones
- t E = Test System
- Lo = Read Log
- Ch = Change Chime
- Uc = User Code

When the screen is flashing this should be interpreted as "DO YOU WANT TO"  
**Pressing 0 (quit) when any screen is flashing will return the system to unset.**  
**Pressing YES when any of the screens are flashing will enter into that option**

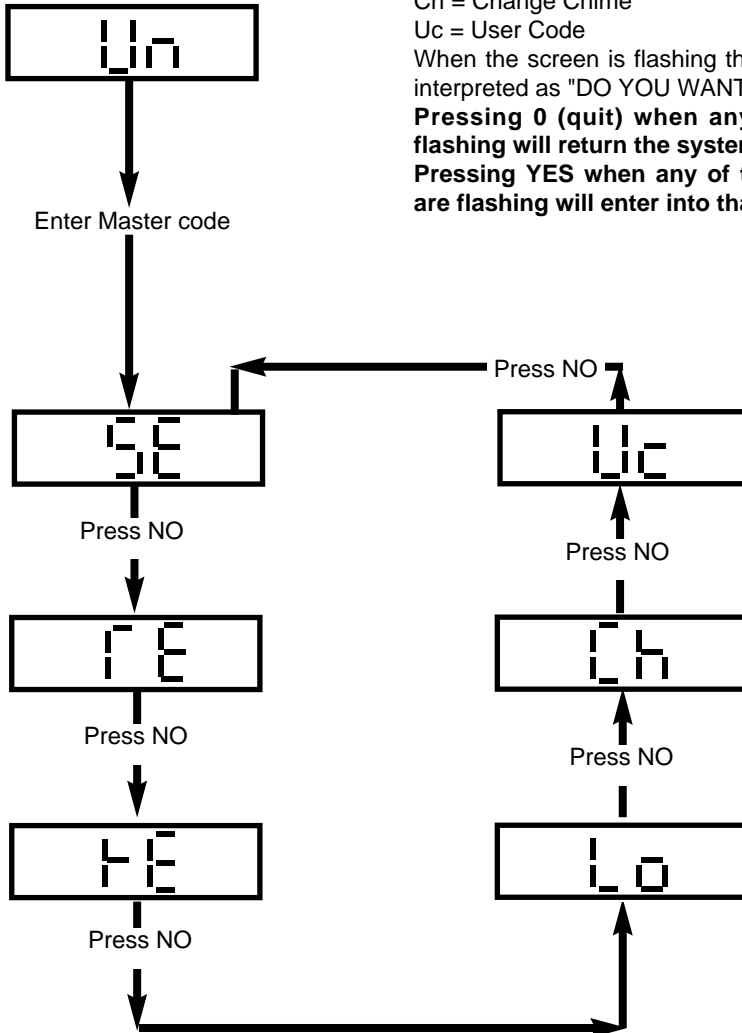

## Setting and Unsetting the System

With the system Unset (display showing 'Un') enter a Master code and screen will flash

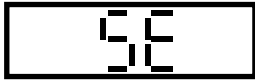

**OR**

With system Unset enter code other than Master (eg User code) & system will start to Set then:-

**Whilst the system is setting.**

**Press 1 to Part 1 Set the system.**

**Press 2 to Part 2 Set the system.**

**Press 3 to Part 3 Set the system.**

**To Unset the system enter premises via authorised route and enter code.**

**Note:**

**When the system starts to set a short delay will be noticed before the exit sounder is activated. This delay allows lower levels of codes to silent part set the system without the exit sounder operating.**

**To abort setting during exit Re-enter code.**

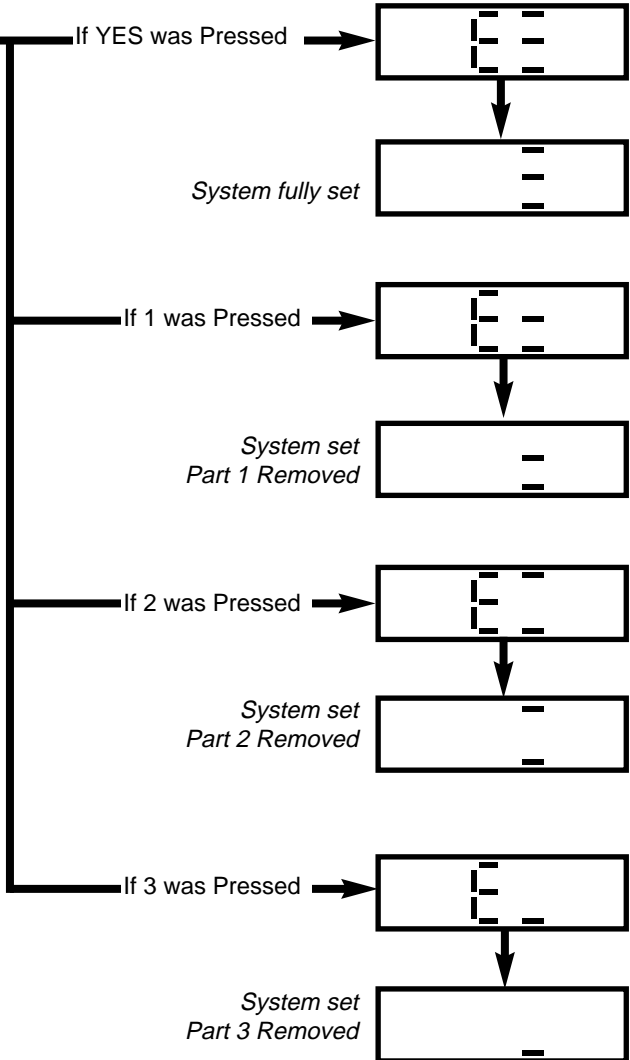

## Removing Zones then Setting the system

With the system Unset  
 Enter **Master code** and press  
 NO until screen flashes:-

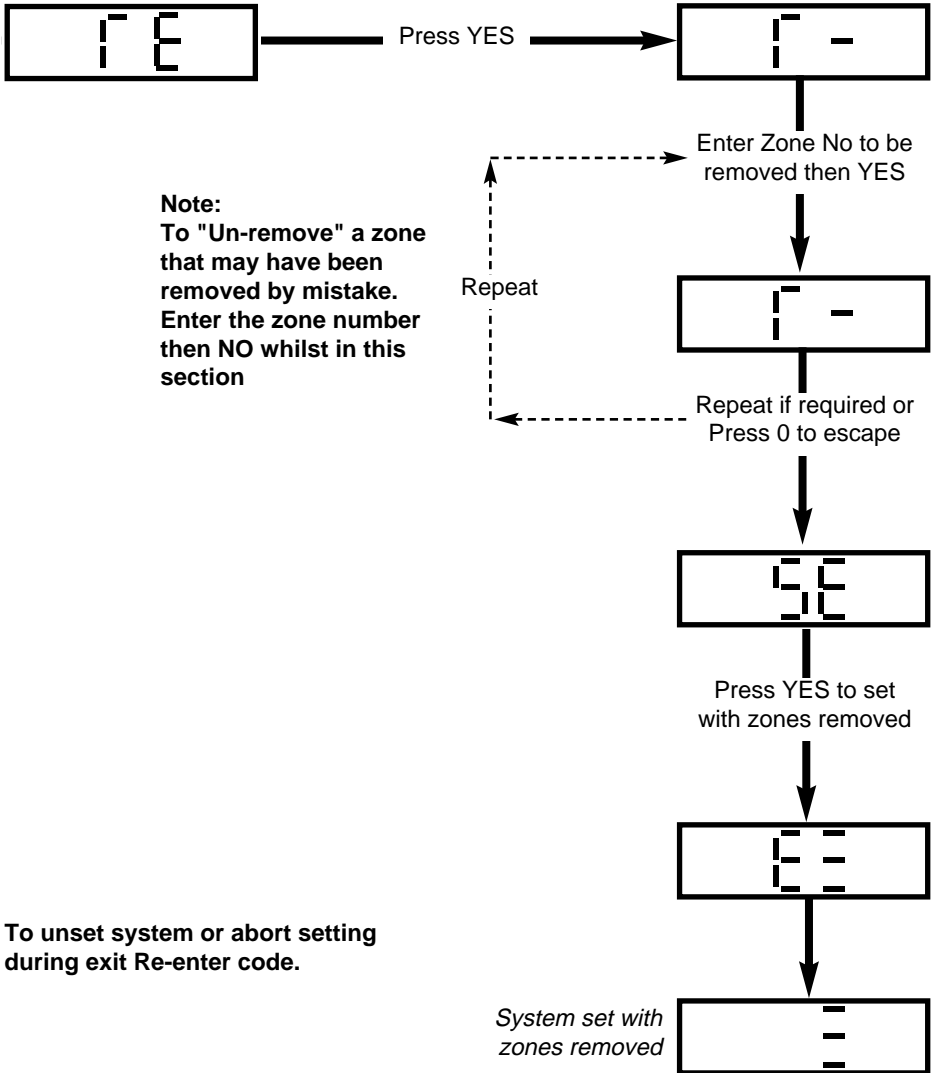

## Testing the System

---

With the system Unset  
 Enter **Master Code** and press  
 NO until screen flashes:-

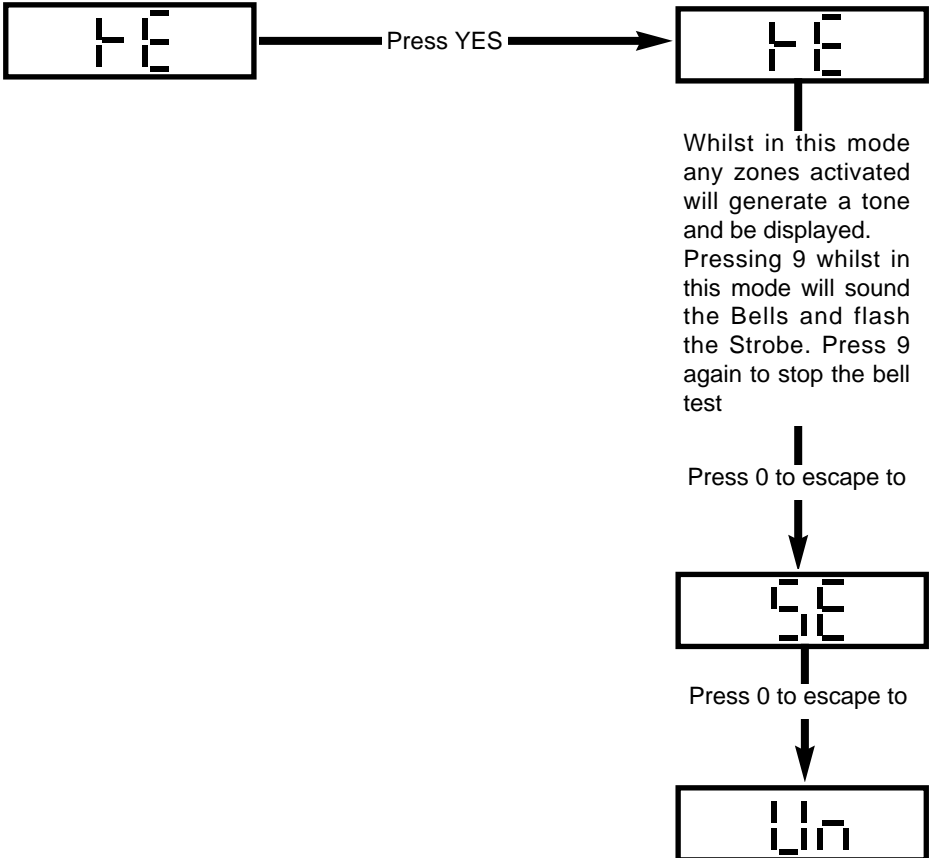



## Viewing the Log

---

With the system Unset  
 Enter **Master Code** and Press  
 NO until screen flashes.

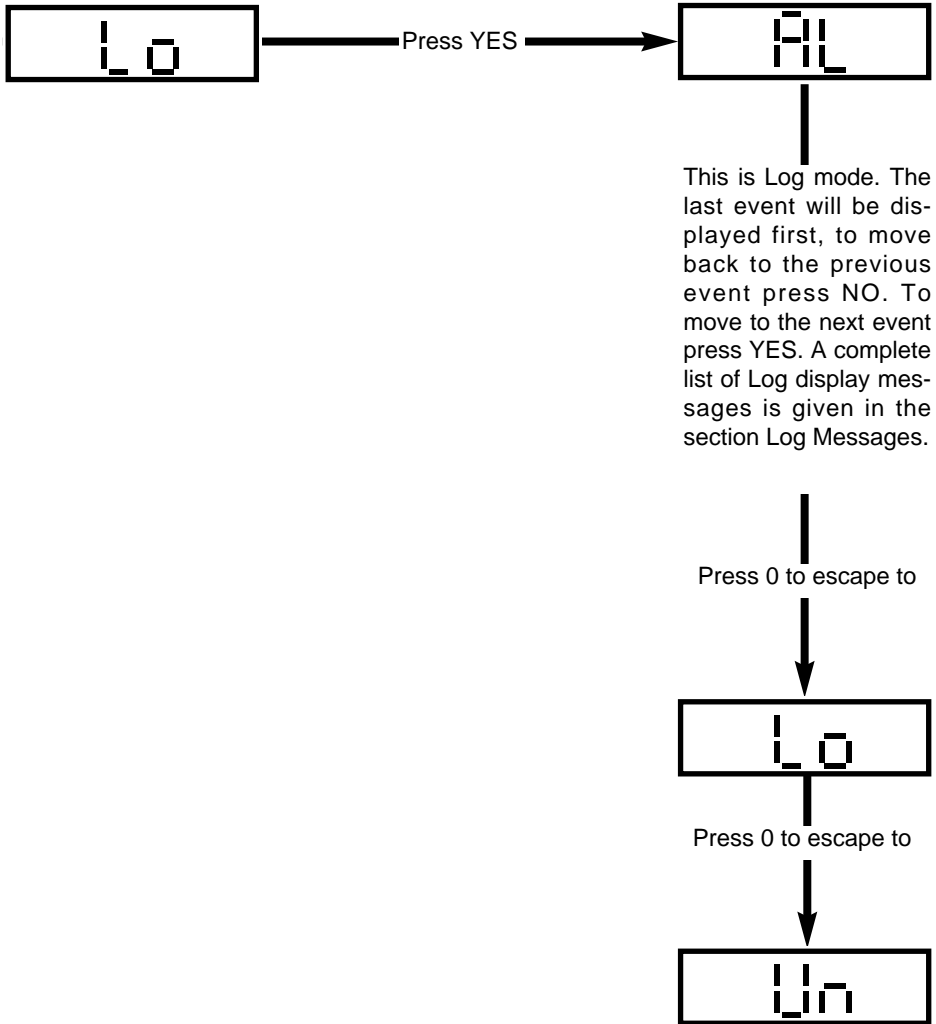

## Setting Chime On/Off

With system Unset

Enter **Master Code** and press

NO until screen flashes.

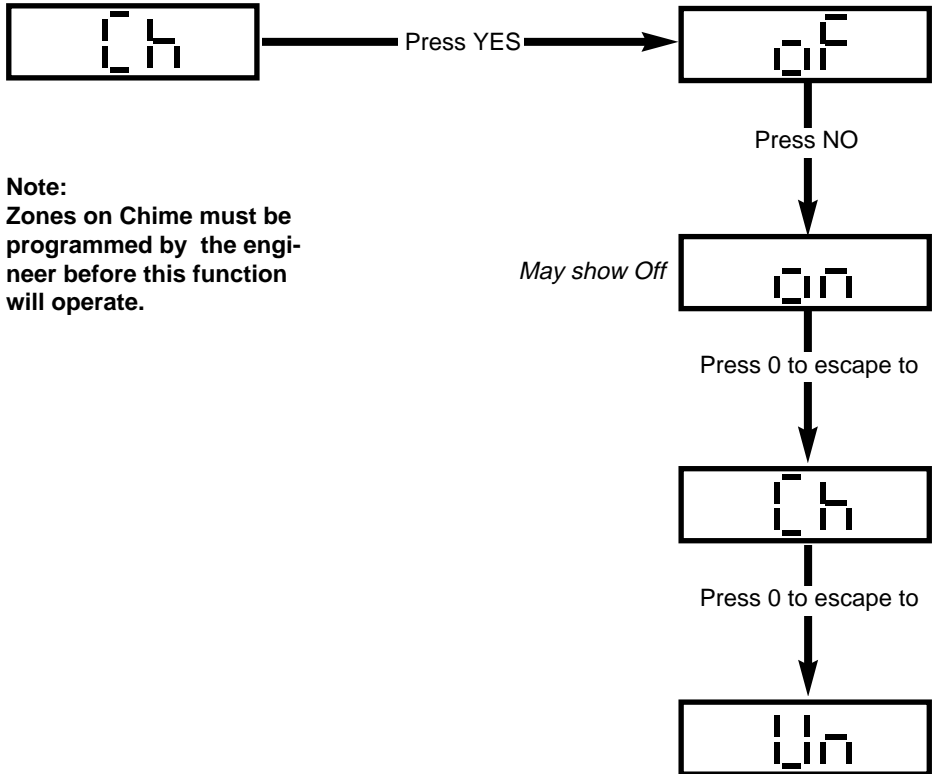

**Note:**

Zones on Chime must be programmed by the engineer before this function will operate.

## Changing Codes

With system Unset

Enter **Master Code** and press

NO until screen flashes.

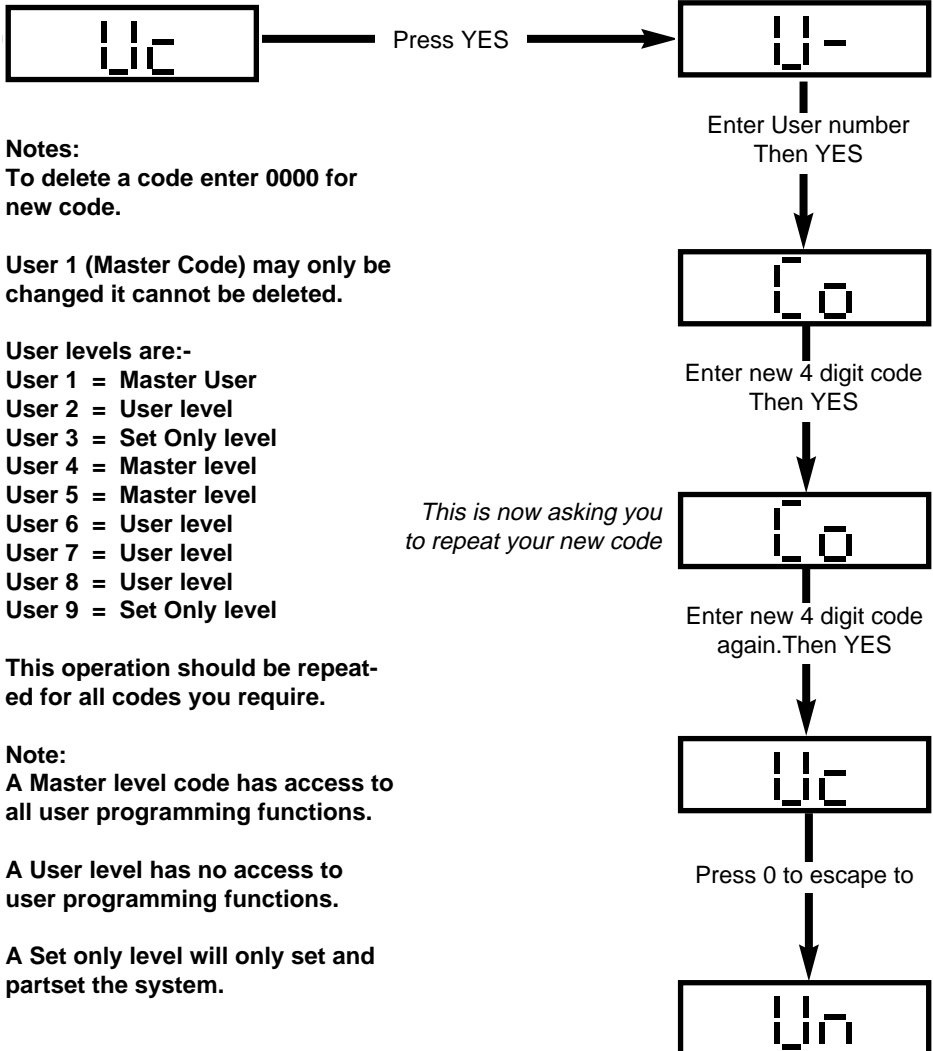

**Notes:**

To delete a code enter 0000 for new code.

User 1 (Master Code) may only be changed it cannot be deleted.

User levels are:-

User 1 = Master User

User 2 = User level

User 3 = Set Only level

User 4 = Master level

User 5 = Master level

User 6 = User level

User 7 = User level

User 8 = User level

User 9 = Set Only level

This operation should be repeated for all codes you require.

**Note:**

A Master level code has access to all user programming functions.

A User level has no access to user programming functions.

A Set only level will only set and partset the system.

## Resetting After an Alarm

---

One of four reset modes may have been programmed by your engineer.

### **Any Code**

The system will reset the next time Any Code is used to set the system.

### **Master Code**

The system will only reset if the Master Code or Engineer code is used to set the system.

### **Engineer Code**

The system will only reset if the Engineer Code is used to set the system.

### **Anti-Code**

The system may only be reset by use of an Anti-Code obtained from your engineer or central station.

### **To Reset System:-**

Enter Code of correct type (see above).

Proceed to set the system.

If a set is not required re-enter the code to abort setting.

### **To Reset by Anti-Code:-**

Make a note of the digit code given by the display when you try to set the system.

Contact your engineer or central station as instructed by the installation company and give them the four digit number given by the display.

The resulting Anti-Code given by them is then entered into the Control Panel to reset it.

**Note: This resulting code may also use the YES and NO keys.**

## Display Messages (System)

---

The Following System messages are possible.

'1 to 6 or 7'	Represent zones 1 to 6 ( 1 to 7 on Gardtec 580 )
'r1'	RKP zone
't'	Tamper zone
'CA'	Control panel Alert keys activated
'Fb'	Fuse Fail or Battery Fault
'bb'	Bell box Tamper
'Cb'	Control Box or Key press Tamper
'Ct'	RKP Tamper
'Pc'	Mains Power Cut
'Ac'	Anti-Code reset required

## Display Messages (Status)

---

'Un'	System is Unset (Day Mode)
'E ≡'	System Full Setting
'E ='	System Part 1 Setting
'E ▬'	System Part 2 Setting
'E _'	System Part 3 Setting
' ≡'	System Fully Set
' ='	System Part 1 Set
' ▬'	System Part 2 Set
' _'	System Part 3 Set
'AL'	An Alarm has occurred (Press NO to view the cause)

## Display Messages (Log)

---

Apart from the System and Status displays the following messages may also appear whilst viewing the Log.

'S ≡'	System Full Set	
'S ='	System Part 1 Set	
'S ≡'	System Part 2 Set	
'S _'	System Part 3 Set	
' o1 '	Unset User 1	
' o2 '	Unset User 2	
' o3 '	Unset User 3	
' o4 '	Unset User 4	
' o5 '	Unset User 5	
' o6 '	Unset User 6	
' o7 '	Unset User 7	
' o8 '	Unset User 8	
' o9 '	Unset User 9	
' o0 '	Unset User 0 (Engineer)	<i>The system may only be unset by the engineer code if it was previously set by the engineer code.</i>
' AL '	Alarm has occurred	
'(1-7)' (flashing)	Zone (1-7) was removed	
' rE '	Electronic watchdog reset (engineer message).	

## Glossary of Terms

---

Full Set	To arm the system with all zones active.
Part Set 1, 2 or 3	To arm the system with a group of zones (pre-programmed by the engineer) removed (omitted).
Unset	To disarm (turn off the system).
Reset	To return to the unset (ready to use condition) usually after an alarm.
Remove	To remove (omit) a zone when setting the system. This is in addition to any pre-programmed Part Sets.
Test	To check the system e.g walk test zones and test Bells/Sounders.
Log	A history of events.
Chime	When the system is unset any chime zones activated will emit a low volume tone from the internal speaker(s)
User Codes	Users will have a User number (1-9) and the Master User may program a four digit 'Pin Number' for each User (see programming user codes for more details).
Zone	An area protected by the alarm system.
Abort	To re-enter premises before exit time has elapsed would require the setting to be aborted by re-entering the code.